

ITEM NO.	PART NUMBER	DESCRIPTION	FINISH	WEIGHT (PER)	QTY.
1	RT1010.07	7' TRAY ANGLE (L2" x 2" x 3/16")	H.D.G.	16.86	4
2	RT1010.02	8'-4" BOTTOM SIDE RAIL ANGLE (L2" x 2" x 3/16")	H.D.G.	20.05	2
3	RT1010.10	6' VERTICAL UPRIGHT ANGLE (L2" x 2" x 3/16")	H.D.G.	14.40	2
4	RT1010.08	8'-4" DIAGONAL BRACE ANGLE (L2" x 2" x 3/16")	H.D.G.	20.09	4
5	RT1010.11	FACE ANGLE ATTACHMENT CLIP (L2" x 2" x 3/16" x 4")	H.D.G.	0.79	4
6	RT1010.05	10'-6" FACE ANGLE (L2" x 2" x 3/16")	H.D.G.	25.09	2
7	RT1210	1/2" x 18" x 48" RUBBER MAT	N/A	18.50	4
8	GB03105	3/8" x 1" BOLT	H.D.G.	0.05	25
9	GL03	3/8" LOCK WASHER	H.D.G.	0.01	25
10	GN03	3/8" HEX NUT	H.D.G.	0.02	25
11	GF03	3/8" FLAT WASHER	H.D.G.	0.02	4

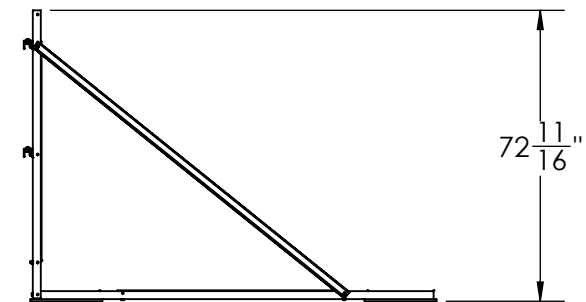
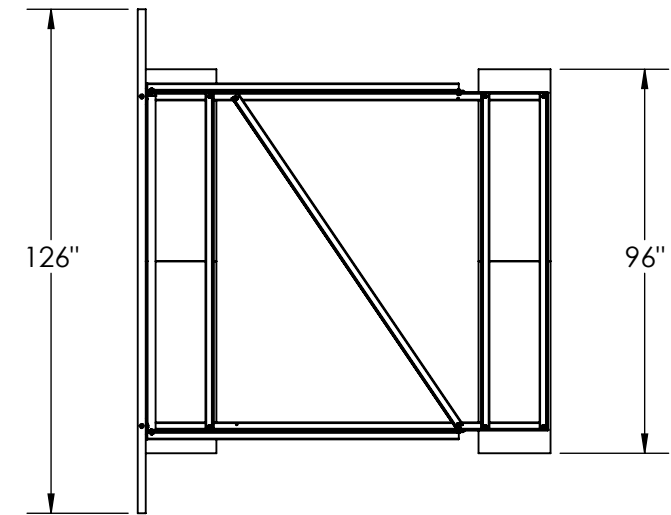
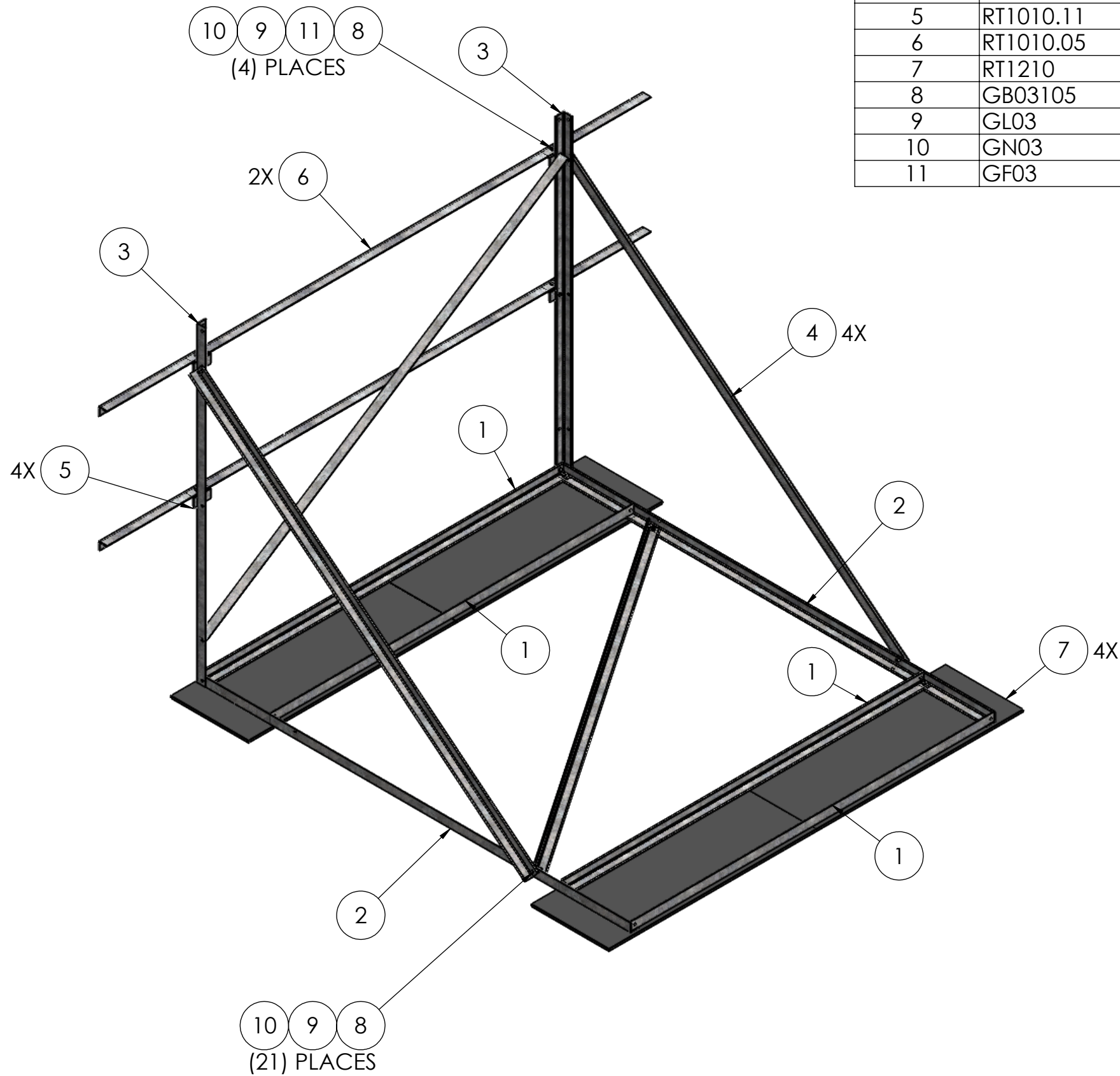

MATERIAL -	FINISH H.D.G.	SIZE B	UNLESS OTHERWISE SPECIFIED: DIMENSIONS ARE IN INCHES TOLERANCE ± 1/16	DESCRIPTION: 10'-6" ROOF FRAME, NO PIPE MOUNTS	DWG NO: RT1010
			PROPRIETARY AND CONFIDENTIAL THE INFORMATION CONTAINED IN THIS DRAWING IS THE SOLE PROPERTY OF PRO TOWER MANUFACTURING L.L.C. ANY REPRODUCTION IN PART OR AS A WHOLE WITHOUT THE WRITTEN PERMISSION OF PRO TOWER MANUFACTURING L.L.C. IS PROHIBITED.	 PRO TOWER MANUFACTURING L.L.C. 5601 San Francisco St. NE Albuquerque, N.M. 87109 (505) 924-2810	DRAWN BY: AJK CHECKED BY: E.FILMER SHEET: 1 of 1